



Movella[™]

Document XD0202P, Revision A, July 2023

Movella DOT iOS SDK Documentation



Revision	Date	By	Changes
A	July 2023	ERI, MRA	Movella DOT Rebranding

© 2005-2023, Movella Technologies B.V. All rights reserved. Information in this document is subject to change without notice. Movella, MVN, MotionGrid, MTi, MTi-G, MTx, MTw, Awinda, Movella DOT and KiC are registered trademarks or trademarks of Movella Technologies B.V. and/or its parent, subsidiaries and/or affiliates in The Netherlands, the USA and/or other countries. All other trademarks are the property of their respective owners.

Table of Contents

1	Introduction	7
2	Getting Started with SDK	8
2.1	Platform Requirements	8
2.2	Example code	8
2.3	SDK Changelogs	8
2.4	Import SDK Framework	8
3	Classes and methods	9
3.1	DotConnectionManager	9
3.2	DotConnectionDelegate	9
3.3	DotDevice	9
3.3.1	Properties	9
3.3.2	Methods	10
3.4	DotPlotData	11
3.5	DotDefine	11
3.6	DotUtils	12
3.7	DotLog	12
3.8	DotReconnectManager	12
3.9	DotSyncManager	12
3.10	DotRecording	12
3.11	DotDevicePool	13
4	SDK Usage with Examples	14
4.1	Recommended workflow	14
4.2	Debugging Flag	15
4.3	Reconnection Setting	15
4.3.1	Enable Reconnect Manager	15
4.3.2	Bind the sensor	15
4.4	BLE Scan	15
4.5	Connect	16
4.6	Initialization	16
4.7	Filter profile	16
4.8	Output rate	17
4.9	Synchronization	18
4.9.1	Get sync status	19
4.9.2	Start sync	19

4.9.3	Get sync results.....	19
4.9.4	Stop sync	19
4.10	Real-time streaming	20
4.10.1	Set measurement mode	20
4.10.2	Start measurement and set data block	20
4.10.3	Stop measurement	21
4.10.4	Data Logging.....	21
4.10.5	High fidelity modes	21
4.10.6	Data conversions	21
4.11	Heading reset	23
4.11.1	Check if heading reset is supported	23
4.11.2	Heading reset status	23
4.11.3	Reset heading	24
4.11.4	Revert heading	24
4.12	Recording.....	25
4.12.1	Get flash information.....	25
4.12.2	Start recording	26
4.12.3	Get recording status.....	26
4.12.4	Stop recording.....	27
4.12.5	Get recording time.....	27
4.12.6	Erase flash	27
4.13	Recording data export.....	28
4.13.1	Set export data format	28
4.13.2	Get export file information	29
4.13.3	Set export file list	29
4.13.4	Start export	30
4.13.5	Stop export.....	30
4.13.6	Update export status.....	30
4.14	Firmware update	31
4.14.1	Set the delegate	31
4.14.2	Check firmware update.....	31
4.14.3	Check firmware downgrade	32
4.14.4	Start OTA	32
4.14.5	Stop OTA.....	33
4.14.6	Clear the cache file	33
4.15	Mag field mapper	34
4.15.1	Integrate MFM SDK framework	34
4.15.2	Implementation MFM.....	35
4.16	Other functions	35
4.16.1	Read RSSI	35
4.16.2	Identify	35
4.16.3	Power saving.....	36
4.16.4	Button callback.....	36
4.16.5	Power on options	36
5	Appendix.....	37
5.1	Real-time streaming modes	37
5.1.1	Extended (Quaternion)	37

5.1.2	Complete (Quaternion)	37
5.1.3	Orientation (Quaternion)	37
5.1.4	Extended (Euler)	37
5.1.5	Complete (Euler)	38
5.1.6	Orientation (Euler)	38
5.1.7	Free acceleration	38
5.1.8	High fidelity (with mag)	38
5.1.9	High fidelity	38
5.1.10	Delta quantities (with mag)	39
5.1.11	Delta quantities	39
5.1.12	Rate quantities (with mag)	39
5.1.13	Rate quantities	39
5.1.14	Custom mode 1	39
5.1.15	Custom mode 2	40
5.1.16	Custom mode 3	40
5.1.17	Custom mode 4	40
5.1.18	Custom mode 5	40

List of Tables

Table 1:	Software supported platforms	8
Table 2:	Methods in DotConnectionManager	9
Table 3:	Methods in DotConnectionDelegate	9
Table 4:	Properties of DotDevice	9
Table 5:	Methods in DotDevice	10
Table 6:	Notifications of DotDefine	11
Table 7:	Methods in DotUtils	12
Table 8:	Methods in DotLog	12
Table 9:	Methods in DotReconnectManager	12
Table 10:	Methods in DotSyncManager	12
Table 11:	Properties in DotRecording	13
Table 12:	Methods in DotDevicePool	13
Table 13:	Filter profile index	17
Table 14:	Output rates	17
Table 15:	Heading status	24
Table 16:	Flash status	26
Table 17:	Recording status	26
Table 18:	Export data quantities	29
Table 19:	Export status	30
Table 20:	Extended (Quaternion)	37
Table 21:	Complete (Quaternion)	37
Table 22:	Orientation (Quaternion)	37
Table 23:	Extended (Euler)	37
Table 24:	Complete (Euler)	38
Table 25:	Orientation (Euler)	38
Table 26:	Free acceleration	38
Table 27:	High fidelity (with mag)	38
Table 28:	High fidelity	38
Table 29:	Delta quantities (with mag)	39
Table 30:	Delta quantities	39

Table 31: Rate quantities (with mag)	39
Table 32: Rate quantities	39
Table 33: Custom mode 1	39
Table 34: Custom mode 2	40
Table 35: Custom mode 3	40
Table 36: Custom mode 4	40

List of Figures

Figure 1: Movella DOT Mobile SDK Architecture	7
Figure 2: Movella DOT iOS SDK Workflow	14
Figure 3: Synchronization workflow	18
Figure 4: Workflow to start and stop real-time streaming	20
Figure 5: Workflow for heading reset	23
Figure 6: Workflow to start and stop recording	25
Figure 7: Workflow to export recording data	28

1 Introduction

The Movella DOT iOS SDK is a software development kit for iOS applications on iPhones and iPads. iOS developers can use this SDK to build their applications to scan and connect the sensors, get data in real-time streaming or recording, as well as other functions.

This document mainly addresses SDK usage with example codes. Before getting started with the SDK, it is advised to read [Movella DOT User Manual](#) first to understand the basic functions of the sensor.

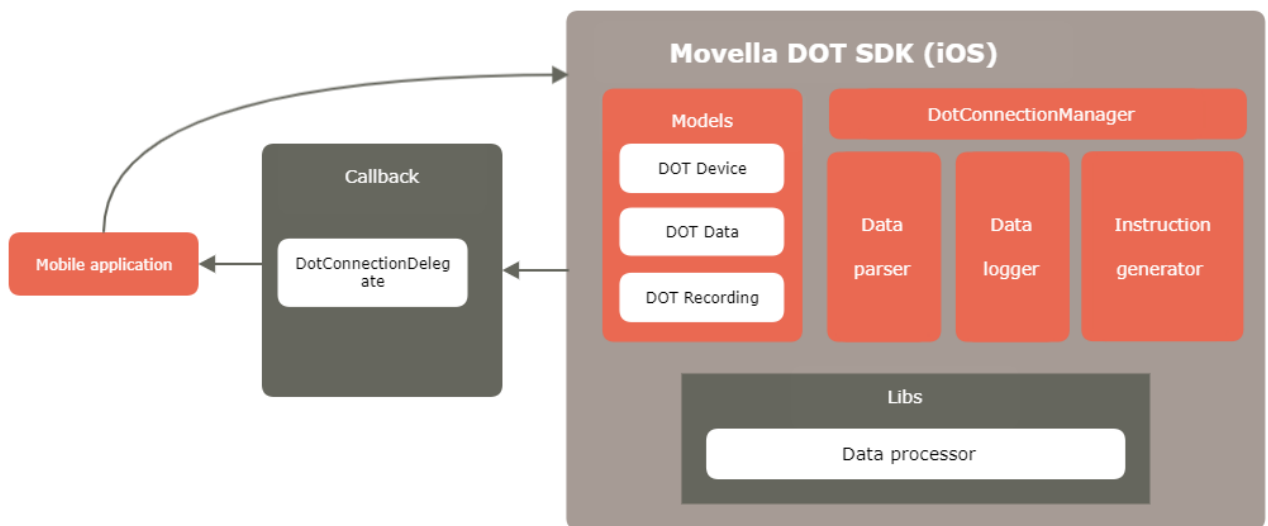

Figure 1: Movella DOT Mobile SDK Architecture

The SDK provides classes for developers to facilitate easier integration into specific application.

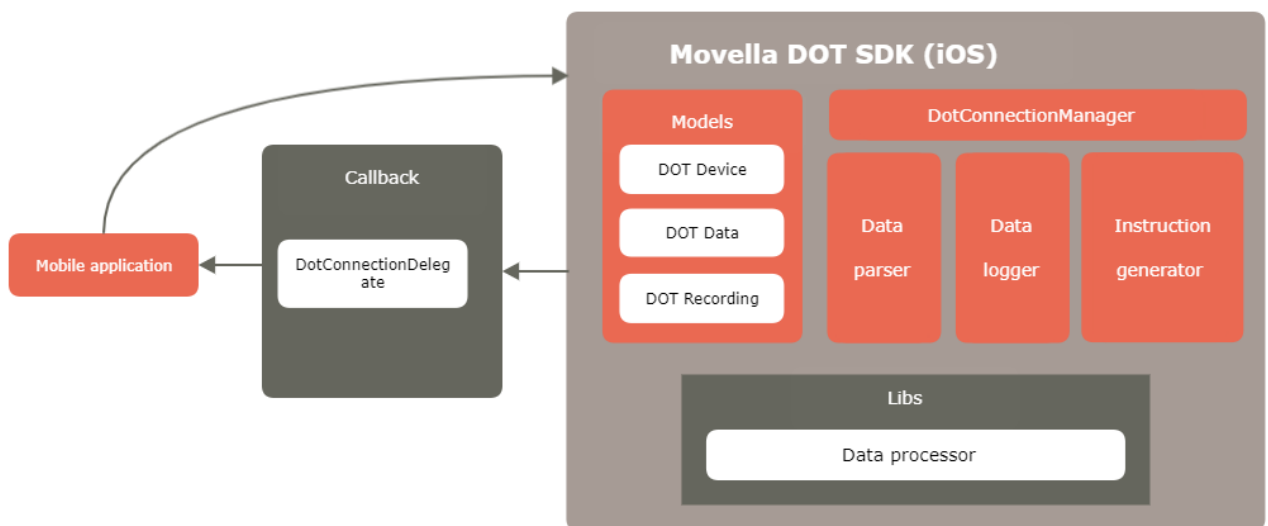

Figure 1 shows the SDK components and architecture. It contains 3 main models to manage the state of device, data payload types and data output. It also contains different

classes¹ available for usage. The data processor library is integrated in SDK to process the data from firmware. Other libraries like sensor fusion and calibration libraries are running on Movella DOT firmware.

¹ Not every class can be new or referenced.

2 Getting Started with SDK

2.1 Platform Requirements

Table 1 shows the iOS version and Bluetooth requirements for the mobile devices.

Table 1: Software supported platforms

Platform requirements
<ul style="list-style-type: none">• iOS 13.0 and above• Bluetooth<ul style="list-style-type: none">○ Best performance with BLE 5.2 DLE² supported.○ Compatible with Bluetooth 4.2

2.2 Example code

Refer to this project on GitHub for the iOS example code of Movella DOT SDK:
https://github.com/MovellaTechnologies/dot_example_ios

2.3 SDK Changelogs

Refer to this [BASE article](#) for the iOS SDK changelogs.

2.4 Import SDK Framework

The required development tool is Xcode. The following steps describe how to import the SDK into your Xcode project.

1. Import the whole `MovellaDotSDK.framework` package into the target project.
2. Make sure `MovellaDotSDK.framework` is included in **Target** → **General** → **Framework, Libraries, and Embedded Content**, and the **Embed** property is **'Embed & Sign'**
3. Under **Target** → **Build Settings**, **Enable Bitcode** is **NO**
4. Add these to `Info.plist`
 - `NSBluetoothAlwaysUsageDescription`
 - `NSBluetoothPeripheralUsageDescription`

² Data Length Extension

3 Classes and methods

3.1 *DotConnectionManager*

This class manages the BLE connection of DOT sensors.

Table 2: Methods in *DotConnectionManager*

Method	Description
+ (void)scan	Scan the sensors
+ (void)stopScan	Stop scanning
+ (void)connect:(DotDevice *)device	Connect sensors
+ (void)disconnect:(DotDevice *)device	Disconnect sensors
+ (BOOL)managerStateIsPoweredOn	Check Bluetooth is enabled or not
+ (DotManagerState)managerState	Get Bluetooth status
+ (void)setConnectionDelegate:(nullable id<DotConnectionDelegate>)delegate	Set the connection delegate

3.2 *DotConnectionDelegate*

The protocol of *DotConnectionManager*. You can use these methods to get all the scanning and connection status.

Table 3: Methods in *DotConnectionDelegate*

Method	Description
- (void)onManagerStateUpdate:(DotManagerState)managerState	Return DOT BLE state
- (void)onScanCompleted	Return if the scanning is completed
- (void)onDiscoverDevice:(DotDevice *_Nonnull)device	Return the discovered device
- (void)onDeviceConnectSucceeded:(DotDevice *_Nonnull)device	Return if the connection is success
- (void)onDeviceConnectFailed:(DotDevice *_Nonnull)device	Return if the connection fails
- (void)onDeviceDisconnected:(DotDevice *_Nonnull)device	Return if the device is disconnected

3.3 *DotDevice*

DotDevice represents an DOT device object, including basic information and operations, data measurement and data logging.

3.3.1 Properties

Table 4: Properties of *DotDevice*

Property	Description
uuid	Bluetooth device UUID
macAddress	Device mac address
RSSI	Bluetooth signal indication
Battery	Device battery object
firmwareVersion	Device firmware version
plotMeasureEnable	Measurement state of real-time streaming
plotMeasureMode	Measurement modes of real-time streaming
plotLogEnable	Data logging state

isSupportHeadingReset	A flag to know if this firmware supports heading reset function.
headingStatus	Heading reset status
^headingResetResult	Heading reset result block
timeoutXMinutes	Power saving time in advertisement mode – minute. Valid value: 0~30
timeoutXSeconds	Power saving time in advertisement mode – second. Valid value: 0~60
timeoutYMinutes	Power saving time in connection mode – minute. Valid value: 0~30
timeoutYSeconds	Power saving time in connection mode – second. Valid value: 0~60
totalSpace	The total available internal storage space for recording. Unit is byte.
usedSpace	The used internal storage space of recording. Unit is byte.
recording	The recording object.
exportDataFormat	To set the export data format of recording files.
exportLogEnable	Set to enable/disable the file logging function when exporting recording data.
outputRate	Output rate. The unit is Hz: 1, 4, 10, 12, 15, 20, 30, 60 and 120 (120 Hz only for recording mode)
filterIndex	The filter profile index 0: General filter profile 1: Dynamic filter profile

3.3.2 Methods

Table 5: Methods in DotDevice

Method	Description
- (void)setDidParsePlotDataBlock:(void (^_Nullable)(DotPlotData * _Nonnull plotData))block	Block of data measurement
- (void)setDeviceName:(NSString *)name	Set device tag name
- (void)startIdentifying	Identify sensor
- (void)powerOff	Power off sensor
- (BOOL)startHeadingReset	Start heading reset. "NO" means this feature is not supported with current the firmware.
- (BOOL)startHeadingRevert	Start heading revert. "NO" means this feature is not supported with current the firmware.
- (BOOL)getRecordingStatus	Get sensor's recording state. "NO" means this feature is not supported with current the firmware.
- (BOOL)startRecording:(UInt16) recordingTime	Start recording. "NO" means this feature is not supported with current the firmware.
- (BOOL)stopRecording	Stop recording. "NO" means this feature is not supported with current the firmware.
- (BOOL)getFlashInfo	Get information of recording flash. "NO" means this feature is not supported with current the firmware.
- (void)setFlashInfoDoneBlock:(void (^_Nullable)(XSFlashInfoStatus status))block	Get flash information done block
- (BOOL)getRecordingTime	Get recording time. "NO" means this feature is not supported with current the firmware.
- (BOOL)eraseData;	Request to erase all the recording data space. "NO" means this feature is not supported with current the firmware.
- (void)setEraseDataDoneBlock:(void (^_Nullable)(int success))block	Erase data done block
- (BOOL)getExportFileInfo	Get information of the export recording file. "NO" means this feature is not supported with current the firmware.

- (void)setExportFileInfoDone:(void (^_Nullable)(BOOL success))block	Export file information done block
- (BOOL)startExportFileData	Start export file data. "NO" means this feature is not supported with current the firmware.
- (BOOL)stopExportFileData	Stop export file data. "NO" means this feature is not supported with current the firmware.
- (void)setDidParseExportFileDataBlock:(void (^_Nullable)(DotPlotData * _Nonnull plotData))block	Data block of exported data
- (BOOL)isInitialized	The flag that sensor has been initialized after connection.
- (BOOL)isSynced	The flag of sensor synced.
- (void)setOutputRate:(int)outputRate filterIndex:(int)filterIndex	Set the output rate and filter index.
- (void)readRSSI:(void (^_Nullable)(NSNumber *signal))block	Read the RSSI of sensor
- (void)setDidButtonCallbackBlock:(void (^_Nullable)(int timestamp))block	The button callback block.
- (BOOL)isProductV2	"YES" means the hardware is Movella DOT v2.
- (BOOL)isProductV1	"YES" means the hardware is Movella DOT v1.
- (BOOL)isUsbPowerOnEnabled	"YES" means the sensor will power on with USB plugin. This function is only available in v2.
- (BOOL)enableUsbPowerOn:(BOOL) isEnabled	Enable the sensor to power on by USB plugin. This function is only available in v2.

3.4 DotPlotData

DotData contains all the measurement data. When set *setPlotMeasureEnable* to YES, the block will get the data from *setDidParsePlotDataBlock*.

Refer to *DotPlotData.h* for more information.

3.5 DotDefine

DotDefine is a common define of SDK. It has notifications and other defines. Please import it in your Xcode project.

Table 6: Notifications of DotDefine

Notification	Description
kDotNotificationManagerStateDidUpdate	Bluetooth state update
kDotNotificationDeviceConnectSucceeded	Sensor connection success notification
kDotNotificationDeviceConnectFailed	Sensor connection failure notification
kDotNotificationDeviceDidDisconnect	Sensor disconnection notification
kDotNotificationDeviceBatteryDidUpdate	Battery level update
kDotNotificationDeviceFirmwareVersionDidRead	Firmware version read success
kDotNotificationDeviceNameDidRead	Tag name read success
kDotNotificationDeviceMacAddressDidRead	Mac address read success
kDotNotificationDeviceConnectionDidStart	Sensor starts connecting notification

Refer to *DotDefine.h* for more information.

3.6 DotUtils

The utils class contains the available conversion methods.

Table 7: Methods in DotUtils

Method	Description
+ (void)quatToEuler:(double [_Nullable])eular WithW:(float)quatW withX:(float)quatX withY:(float)quatY withZ:(float)quatZ	Convert quaternion to Euler angles

3.7 DotLog

Enable *DotLog* when you want to get debug information. Note that you need to disable it in released apps.

Table 8: Methods in DotLog

Method	Description
+ (void)setLogEnable:(BOOL)enable	Enable/disable debug mode
+ (BOOL)isLogEnable	Get debug mode state

3.8 DotReconnectManager

When *setEnabled* is set to **YES**, the sensor will automatically reconnect every second if the connection is lost.

Table 9: Methods in DotReconnectManager

Method	Description
+ (void)setEnable:(BOOL)enable	Enable/disable reconnection
+ (BOOL)enable	Get current reconnection state

3.9 DotSyncManager

This class is the synchronization manager. All sensors will be time-synced with each other to a common time base after synchronization. Refer to section 3.3.4 in [Movella DOT User Manual](#) for more information. The root node in the iOS SDK is always the first sensor connected. It will take the sensors about 10 seconds to finish the sync period, so you can reconnect the sensors after that.

Table 10: Methods in DotSyncManager

Method	Description
+ (void)startSync:(NSArray<DotDevice *> *)devices result:(DotSyncResultBolck) resultBlock	Start synchronization
+ (void)stopSync:(NSArray<DotDevice *> *)devices	Stop synchronization

3.10 DotRecording

This class has all the properties of recording, including *flashInfoStatus*, *recordingStatus*, *recordingdata*, *recordingTime* etc. *DotDevice* has a property of recording, you can control it after *DotDevice* connected.

Table 11: Properties in DotRecording

Property	Description
flashInfoStatus	The status of flash information, refer to table?
recordingStatus	The status of recording, refer to table?
^updateRecordingStatus	Recording status update block
^updateExportingStatus	Export file data status update block
recordingDate	Recording start time UTC, the unit is second
recordingTime	The total recording time of a timed recording. For normal recording, the value is 0xFFFF.
remainingTime	The remaining time of a timed recording.
files	The recording file list
exportFileList	Export file list
^exportFileDone	Export file done block

3.11 DotDevicePool

This class manages the reconnection behavior of sensors. When reconnection is enabled, you need to bind the sensor to activate the reconnection function after connecting a sensor. Unbind it after disconnecting the sensor, otherwise a reconnection will be initialized.

Table 12: Methods in DotDevicePool

Method	Description
+ (BOOL)bindDevice:(DotDevice *)device	Bind a sensor
+ (void)unbindDevice:(DotDevice *)device	Unbind a sensor
+ (NSArray <DotDevice *>*)allBoundDevices	All the bound devices

4 SDK Usage with Examples

4.1 Recommended workflow

The iOS SDK code flow is shown in Figure 2. This flow process can be used by iOS developers after importing SDK into iOS project.

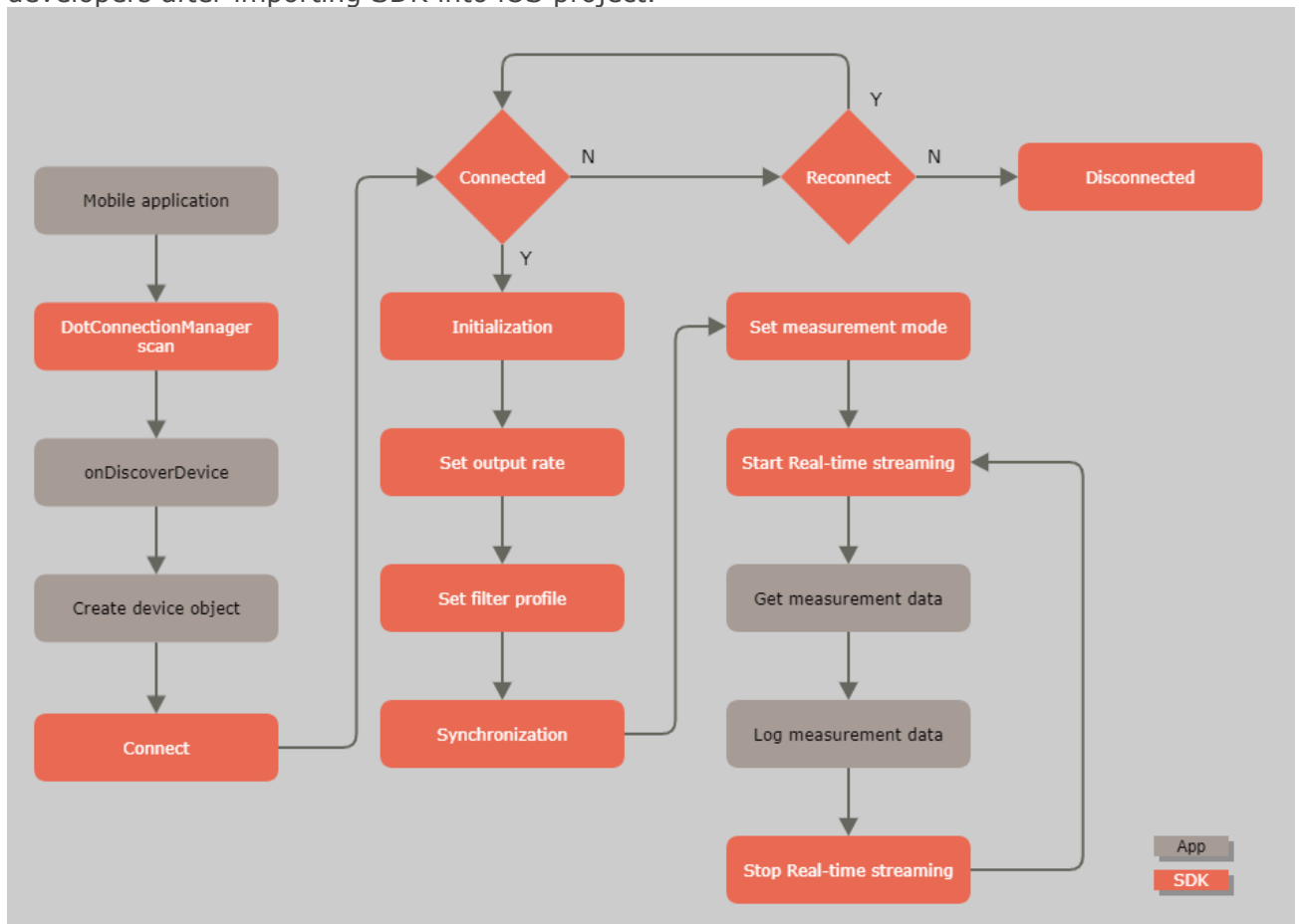

Figure 2: Movella DOT iOS SDK Workflow

Begin with starting BLE scan with *DotConnectionManager scan*. Developers can get the *DotDevice* object using *onDiscoverDevice* method in *DotConnectionDelegate*. *DotDevice* object manages the all the behaviors of the sensor.

Use *DotConnectionManager connect:device* to connect the sensors. The connection status is updated by *DotConnectionDelegate*. If the connection process fails, the SDK will check whether the reconnection feature is enabled. Reconnection will start automatically if enabled.

Each step is further explained in the following sections with example code.

4.2 Debugging Flag

This is a static function and can be used to enable/disable the debug messages. If it is set to true, the SDK will output debug message with this tag – 'MovellaDotSDK'.

```
[DotLog setLogEnable:YES];
```

4.3 Reconnection Setting

Follow these steps to configure the reconnection setting of DOT. If set to true and bound, the SDK will start to reconnect the sensor(s) automatically when the connection is lost.

4.3.1 Enable Reconnect Manager

Enable the reconnect manager in viewController:

```
[DotReconnectManager setEnable:YES];
```

4.3.2 Bind the sensor

Add *bindDevice* after connecting and *unbindDevice* after disconnecting.

```
if(device.state != CBPeripheralStateConnected)
{
    [DotConnectionManager connect:device];
    [DotDevicePool bindDevice:device];
}
else
{
    [DotConnectionManager disconnect:device];
    [DotDevicePool unbindDevice:device];
}
```

4.4 BLE Scan

Before starting the scanning, you must ensure that Bluetooth is on and the iPhone is powered on and available.

```
if(![DotConnectionManager managerStateIsPoweredOn])
{
    NSLog(@"Please enable bluetooth first");
    return;
}
[DotConnectionManager scan];

Set the delegate:
- (void)viewWillAppear:(BOOL)animated
{
    [super viewWillAppear:animated];
    [DotConnectionManager setConnectionDelegate:self];
    xxx
}
```

The *DotConnectionDelegate* has all status of scanning result.

4.5 Connect

Declare an *DotDevice* object or *DotDevice* array.

```
@property (strong, nonatomic) NSMutableArray *deviceList;
```

In *onDiscoverDevice:(DotDevice *)device* of *DotConnectionDelegate*, add all devices to *deviceList*.

```
- (void)onDiscoverDevice:(DotDevice *)device
{
    NSInteger index = [self.deviceList indexOfObject:device];
    if(index == NSNotFound)
    {
        if (![self.deviceList containsObject:device])
        {
            [self.deviceList addObject:device];
        }
    }
}
```

Use *DotConnectionManager* to connect one or multiple sensors.

```
DotDevice *DotDevice = self.deviceList[indexPath.row];
DotConnectionManager connect:DotDevice];
```

Refer to *DotDevice.h* for more information.

4.6 Initialization

After the sensor connection, an initialization process will start automatically to enable BLE notifications and obtain basic sensor information, including the hardware and firmware version, MAC address, tag name, battery status, synchronization status, filter profile, output rate etc.

isInitialized method will tell user whether a sensor has been initialized after connection. Make sure *isInitialized* is YES before proceeding further, such as synchronization and measurement.

4.7 Filter profile

After the initialization is done, you can get or set the current filter profile for the measurement. Refer to section 3.2 in the [Movella DOT User Manual](#) for more information about filter profiles.

Get current filter profile that is applied in the measurement:

```
DotDevice.filterIndex
```

The *filterIndex* is the index of the filter profiles.

Table 13: Filter profile index

Index	Filter profile	Description
0	General	This filter profile is the default setting. It assumes moderate dynamics and a homogeneous magnetic field. External magnetic distortion is considered relatively short.
1	Dynamic	This filter profile assumes fast and jerky motions that last for a short time. The dynamic filter uses the magnetometer for stabilization of the heading and assumes very short magnetic distortions. Typical applications are when sensors are applied on persons for sports such as sprinting.

Set a new filter profile:

```
- (void) setOutputRate:(int) outputRate filterIndex:(int) filterIndex;
```

4.8 Output rate

After the initialization is done, you can get or set the output rate for the measurement. Table 14 shows the available output rates during measurements.

Table 14: Output rates

Measurement	Output rates
Real-time streaming	1 Hz, 4 Hz, 10 Hz, 12 Hz, 15 Hz, 20 Hz, 30 Hz, 60 Hz
Recording	1 Hz, 4 Hz, 10 Hz, 12 Hz, 15 Hz, 20 Hz, 30 Hz, 60 Hz, 120 Hz

Get current output rate that is applied in the measurement:

```
DotDevice.outputRate
```

Set a new output rate for the measurement:

```
- (void) setOutputRate:(int) outputRate filterIndex:(int) filterIndex;
```

4.9 Synchronization

All sensors will be time-synced with each other to a common time base after synchronization. Refer to section 3.3.2 in [Movella DOT User Manual](#) for more information.

Set the output rate and filter profile before starting the synchronization. Since the sensor will enter measurement mode right after the sync succeeds so it's not possible to change it after sync. Figure 3 below shows the recommended workflow for synchronization.

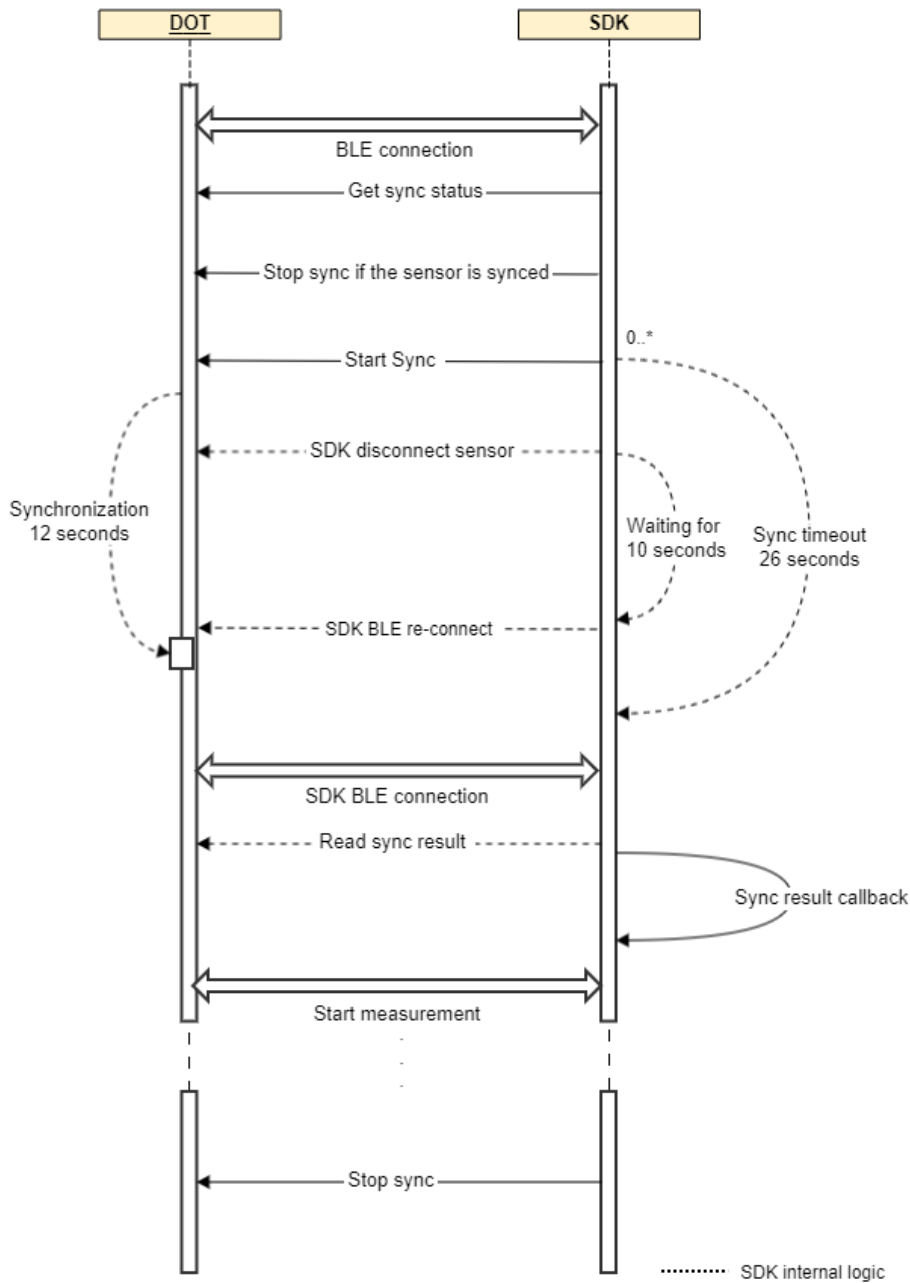

Figure 3: Synchronization workflow

4.9.1 Get sync status

Before starting the synchronization, check the synchronization status of the target sensors and make sure they are not synced. Stop the synced sensor before starting a new synchronization to prevent error status.

Get sync status with *isSynced* method.

4.9.2 Start sync

Use *startSync* method in *DotSyncManager* to start the synchronization. The first param of *startSync* is a *DotDevice* List and second param is a callback block. The first object in the List will be the root sensor while others will be the scanners.

SDK will disconnect the sensor after starting the synchronization. The synchronization of 5 sensors would take about 12 seconds while SDK will try to reconnect after 10 seconds.

4.9.3 Get sync results

After a successful reconnection, SDK will check the sync result to see if the sync is successful or not. The block param is an array object that includes the *DotDevice* *macAddress* and sync result.

```
#import <MovellaDotSdk/DotSyncManager.h>
...

DotSyncResultBlock block = ^(NSArray *array)
{
};

[DotSyncManager startSync:self.DotDeviceList result:block];
```

Once the sync succeeds, sensor will enter measurement mode. You can then choose to do real-time streaming or recording with the synced sensors.

If the sensor is not reconnected within 26 seconds, the sync is considered as failed. The sync is also failed if the result shows fail. In that case, SDK will stop those sensors that have been successfully synced. Refer to this [BASE article](#) for more tips about synchronization.

4.9.4 Stop sync

Stop sync is required after the measurement. Otherwise the sensor will stay in measurement mode and the battery will run out soon.

Use *stopSync* method in *DotSyncManager* to stop synchronization. The param is the synced *DotDevice* list.

```
[DotSyncManager stopSync:boundDevices];
```

4.10 Real-time streaming

In real-time streaming, motion data is streamed and logged to the central device via a constant Bluetooth connection. You can set measurement mode, start/stop measurement and log the data to csv files with the SDK.

Figure 4 shows the workflow to start and stop real-time streaming.

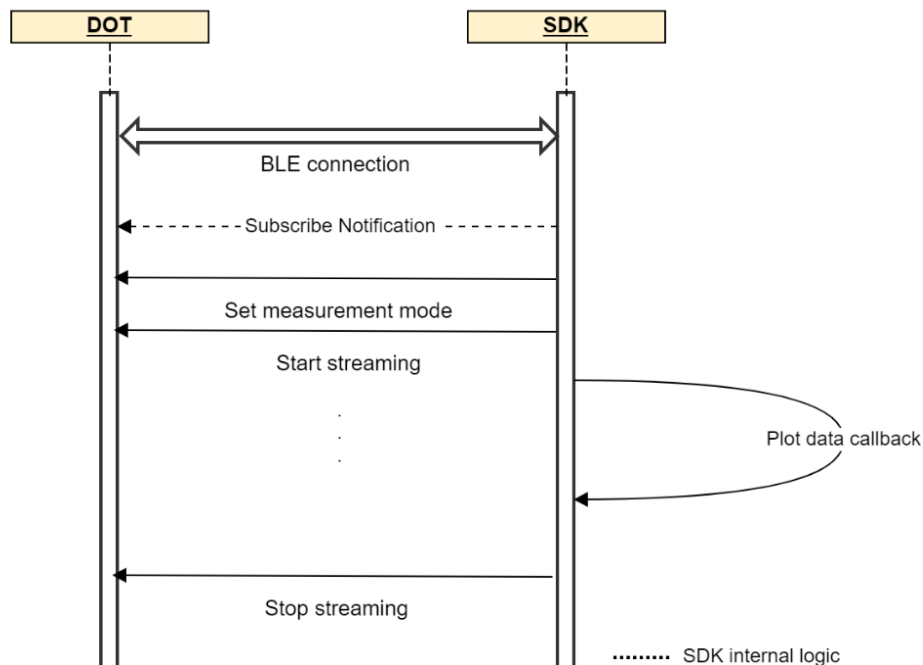

Figure 4: Workflow to start and stop real-time streaming

DotDevice can report sensor data in real-time streaming and the callback is *setDidParsePlotDataBlock* block. To use this, notify the sensor to enter the measurement mode, then start the measurement by following the steps below.

4.10.1 Set measurement mode

You can get all the measurement modes of real-time streaming in this enum: *XSBleDevicePayloadMode*. 17 measurement modes are available for now. Refer to the Appendix for data outputs of different modes. Section 4.2 in [Movella DOT User Manual](#) also gives detailed explanation about output values.

```
[DotDevce setPlotMeasureMode:  
XSBleDevicePayloadInertialHighFidelityWithMag];
```

4.10.2 Start measurement and set data block

```
[DotDevce setPlotMeasureEnable:YES];  
  
[_DotDevice setDidParsePlotDataBlock:^(DotPlotData * __Nonnull  
plotData) {
```

```
double acc0 = plotData.acc0;
double acc1 = plotData.acc1;
double acc2 = plotData.acc2;
...
}];
```

Then you can get the data output according to different measurement modes.

4.10.3 Stop measurement

```
[DotDevice setPlotMeasureEnable:NO];
```

Refer to *DotPlotData.h* for more information.

4.10.4 Data Logging

Call *setPlotLogEnable* method in *DotDevice* to enable or disable the data logging during real-time streaming.

```
[DotDevice setPlotLogEnable:YES]
```

The logging data is saved in 'Logs' folder under *NSDocumentDirectory* as csv files.

4.10.5 High fidelity modes

In high fidelity mode, higher frequency (800 Hz) information is preserved with lower output data rate (60 Hz), even with transient data loss. There are 3 measurement modes containing high fidelity inertial data in the SDK:

- *XSBleDevicePayloadInertialHighFidelityWithMag*
- *XSBleDevicePayloadHighFidelityNoMag*
- *XSBleDevicePayloadCustomMode4*

To parse the high fidelity inertial data to *delta_q*, *delta_v* or calibrated angular velocity and acceleration, you need to select the above measurement modes with high fidelity inertial data. After starting the measurement, you can get the values with read the properties of *acc0-acc2*, *gyr0-gyr2*, *dQ0-dQ3*, *dV0-dV2* from *DotData* object.

4.10.6 Data conversions

Data conversion functions are provided in Movella DOT SDK. Developers can make use of these conversion functions to get the measurement quantities as required in their applications.

Convert quaternion to Euler angles

quatToEuler method is provided in *DotUtils* class to convert quaternion values to Euler angles.

```
DotPlotData *plotData;
[DotDevice setDidParsePlotDataBlock:^(DotPlotData * _Nonnull plotData)
{
    plotData = plotData;
}];
```

```
double eular[3];

[DotUtils quatToEuler:eular WithW:plotData.quatW withX:plotData.quatX
withY:plotData.quatY withZ:plotData.quatZ];
```

Calculation of free acceleration

You can get the free acceleration from orientation and acceleration as mentioned in this [BASE article](#).

In real-time streaming, *getCalFreeAcc* function is provided to help you omit the mathematical calculations.

As this function requires both orientation (in quaternion) and acceleration as input it can currently only be used with *XSBleDevicePayloadCustomMode4*. Custom mode 4 is the only mode that can output these two quantities at the same time.

```
Double *calFreeAcc = [plotData getCalFreeAcc];
//calFreeAcc[0] is free acceleration along the x-axis
//calFreeAcc[1] is free acceleration along the y-axis
//calFreeAcc[2] is free acceleration along the z-axis
```

The default gravity is 9.8127 m/s². You can set a custom gravity vector (for example 9.82 m/s²) by defining its value in the following way:

```
double localGravity=9.82
[double *calFreeAcc = [plotData getCalFreeAcc:localGravity]
```

4.11 Heading reset

Heading reset function allows user to align heading outputs among all sensors and with the object they are connected to. Performing a heading reset will determine the orientation and free acceleration data with respect to a different earth-fixed local frame (L'), which defines the L' frame by setting the X-axis of L' frame while maintaining the Z-axis along the vertical. It computes L' such that Yaw becomes 0 deg.

The heading reset function must be executed during real-time streaming and with measurement mode including orientation output. The reset orientation is maintained between measurement start/stop and connection/disconnection but will be lost after a device reboot.

Figure 5 shows the workflow to do the heading reset.

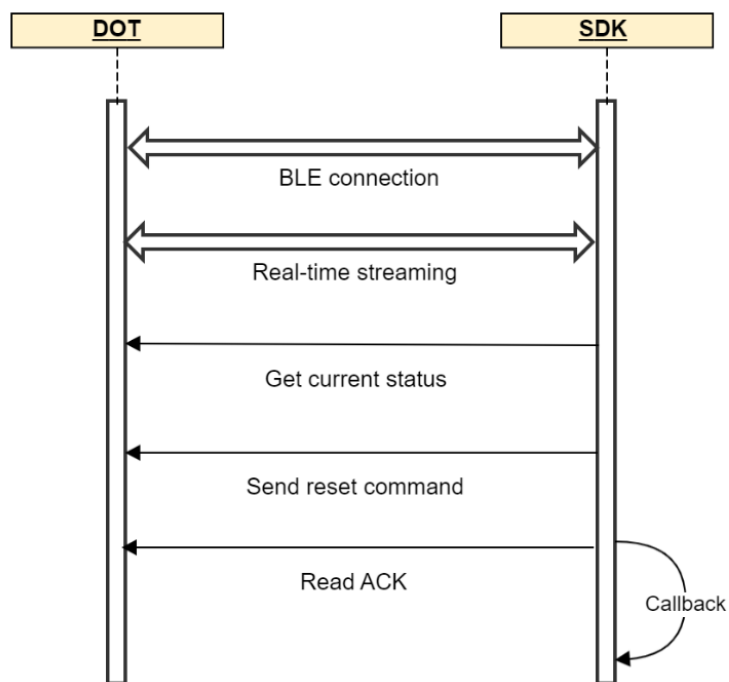

Figure 5: Workflow for heading reset

Follow the steps below to implement the heading reset function.

4.11.1 Check if heading reset is supported

Check if current firmware of the sensor support heading reset feature or not.

```
DotDevice.isSupportHeadingReset
```

4.11.2 Heading reset status

Get the heading reset status of the sensor.

```
DotDevice.headingStatus
```

Table 15: Heading status

Heading reset status	Value	Description
XSHHeadingStatusXrmHeading	1	Heading has been reset
XSHHeadingStatusXrmDefaultAlignment	7	Heading has been reverted to default status
XSHHeadingStatusXrmNone	8	Default status

4.11.3 Reset heading

Align the sensor heading to 0 degree. Only reset the sensor which is reverted or in default status (status = 7 or 8).

```
[DotDevice startHeadingReset]
```

4.11.4 Revert heading

Revert heading to the default value. Note that only revert the sensor which is reset (status = 1).

```
[DotDevice startHeadingReset]
```

After reset the heading, a revert is required before conducting a new reset.

4.12 Recording

In recording mode, motion data is stored in the sensor internal storage and can be exported for post processing. Bluetooth connection is not required once the recording is started. With the SDK, you can start/stop recording, set timed recording and export recording data.

Figure 6 shows the recommended workflow to start and stop recording with iOS SDK.

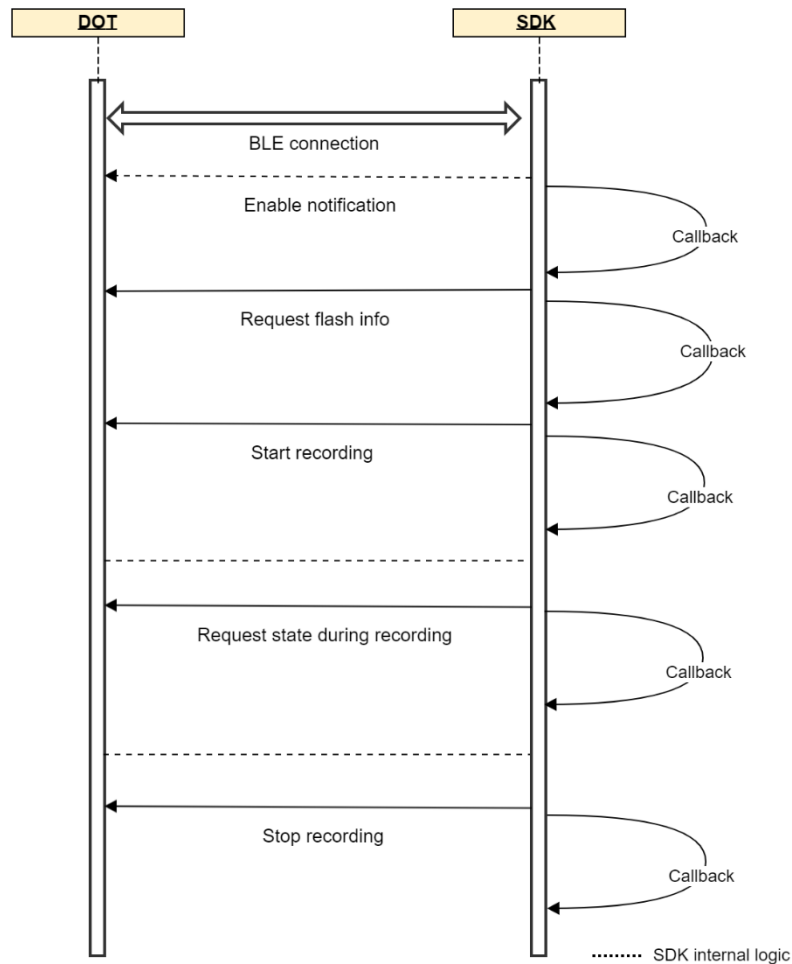

Figure 6: Workflow to start and stop recording

4.12.1 Get flash information

Flash information refers to recording flash size and its usage. The flash size that can be used for recording accounts for about 90% of the total size (16 MB for v1 sensor, 64MB for v2 sensor). So firstly, we need to get the available flash space and the remaining recording time before start recording.

DotDevice.totalSpace and *DotDevice.usedSpce* can only be initialized after calling *getFlashInfo*.

```
[DotDevice getFlashInfo];
```

This can be used to update the flash status:

```
[DotDevice setFlashInfoDoneBlock:^(XSFlashInfoStatus status) { }];
```

Table 16: Flash status

Flash status	Description
XSFlashInfoIsReady	Recording flash space is ready for recording.
XSFlashInfoIsFull	Recording flash space is full ($\geq 90\%$ the whole size).
XSFlashInfoIsUninitialized	Recording flash space is uninitialized or invalid.

Note that uninitialized or invalid flash means that the current recording flash space is not compatible with the flash structure supported in this firmware. Erase the flash space to reset the structure.

4.12.2 Start recording

You can start recording or set a timed recording with the parameter of *startRecording*.

Set the param to 0xFFFF to start recording; the recording will continue unless a stop recording command is received or sensor stops automatically. Set the param to other values to start a timed recording. The unit is second. Note that the maximum recording time of the sensor is 88 minutes.

```
[DotDevice startRecording:0xFFFF];
```

4.12.3 Get recording status

Use *getRecordingStatus* to check the status of recording.

```
[DotDevice getRecordingStatus];
```

After call this method, the *DotDevice.recording.recordingStatus* will be updated with the recording status.

Table 17: Recording status

Recording status	Description
XSRecordingIsIdle	Idle status
XSRecordingIsRecording	Sensor is recording
XSRecordingIsRecordingStopped	Recording is stopped
XSRecordingIsErasing	Erasing recording data
XSRecordingIsFlashInfo	Sensor is getting flash information

In the meantime, *updateRecordingStatus* block will be updated automatically.

```
[DotDevice.recording setUpdateRecordingStatus:^(XSRecordingStatus status) {  
  
}];
```

This block will also be updated after calling *startRecording* and *stopRecording*.

4.12.4 Stop recording

Use *stopRecording* to stop a normal recording or a timed recording.

```
[DotDevice stopRecording];
```

Recording will also stop automatically in the following situations:

- power button is pressed over 1 second.
- time is up for timed recording.
- flash memory is over 90%.

4.12.5 Get recording time

If the *recordingStatus* is *XSRecordingIsRecording*, you can call *getRecordingTime* method to get *recordingDate*, *recordingTime* and *remainingTime*.

```
[DotDevice getRecordingTime];
```

```
DotDevice.recording.recordingDate
// start recording time 4 bytes unit is second.
DotDevice.recording.recordingTime
// recording Time that you startRecording set 2 bytes unit is second.
DotDevice.recording.remainingTime
// the remaining time after you start recording if you set
recordingTime is not 0XFFFF;
```

4.12.6 Erase flash

Erase all the recording data space, other flash space will not be affected.

```
[DotDevice eraseData];
```

setEraseDataDoneBlock will be updated if the erase process is done.

```
[DotDevice setEraseDataDoneBlock:^(int success) {}];
```

4.13 Recording data export

A stand-alone application – Movella DOT Data Exporter is provided to export the recording data to PC via USB cable. You can download Windows or MacOS version in [developers page](#).

Figure 7 shows the recommended workflow to start and stop recording with SDK.

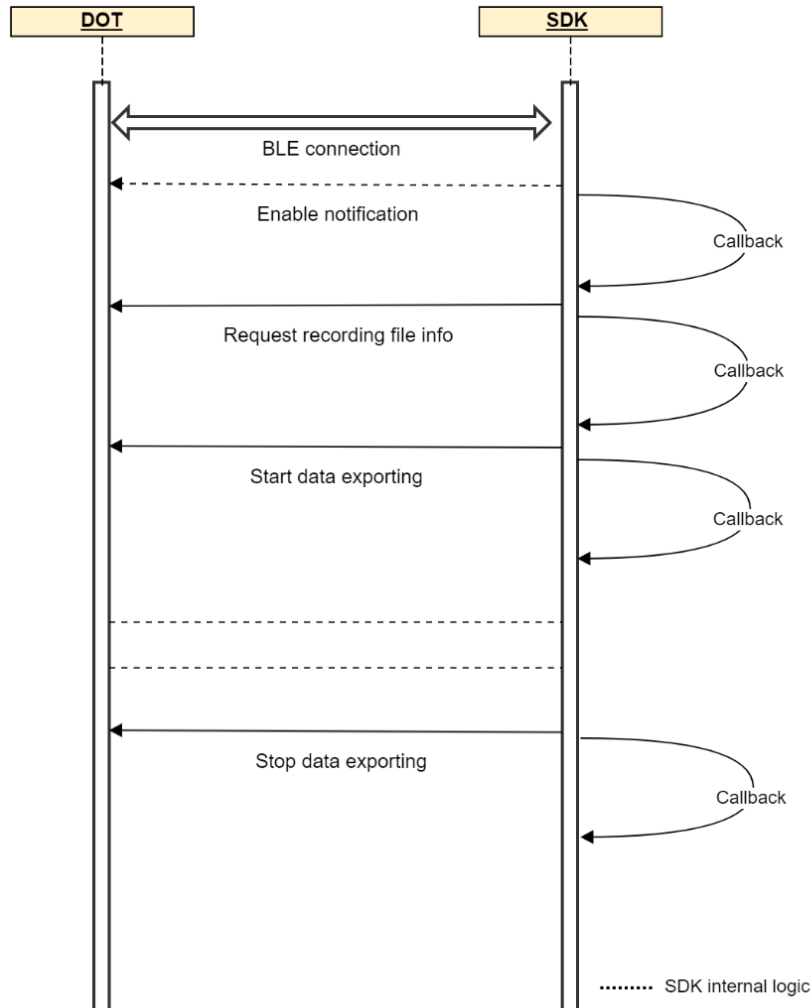

Figure 7: Workflow to export recording data

Follow the steps below to implement data export function in your application.

4.13.1 Set export data format

Refer to Table 18 for available data quantities when configuring the export data format. For physical meanings and other information of the data, please refer to chapter 4 in [Movella DOT User Manual](#).

Note that free acceleration is not provided in this firmware. Refer to this [BASE article](#) to calculate free acceleration from orientation (quaternion) and acceleration.

Table 18: Export data quantities

Data	Description
XSRecordingDataTimestamp	TimeStamp
XSRecordingDataQuaternion	Quaternion
XSRecordingDataEulerAngles	Euler angles
XSRecordingDataDq	dq
XSRecordingDataDv	dv
XSRecordingDataAcceleration	Calibrated acceleration
XSRecordingDataAngularVelocity	Calibrated angular velocity
XSRecordingDataMagneticField	Calibrated magnetic field
XSRecordingDataStatus	Status
XSRecordingDataClipCountAcc	clipCountAcc
XSRecordingDataClipCountGyr	clipCountGyro

If *exportDataFormat* is not set, the default value is:

- XSRecordingDataTimestamp
- XSRecordingDataEulerAngles
- XSRecordingDataAcceleration
- XSRecordingDataAngularVelocity

```
UInt8 bytes[4] = { XSRecordingDataTimestamp, XSRecordingDataQuaternion
, XSRecordingDataDq , XSRecordingDataDv };
NSData *exportData = [NSData dataWithBytes:defaultBytes
length:sizeof(bytes)];
DotDevice.exportDataFormat = exportData;
```

4.13.2 Get export file information

You can use the *getExportFileInfo* method to get the start time UTC of the recording files. *DotDevice.recording.files* will be initialized only after calling *DotDevice.getFlashInfo*. Since part of the file information is written in flash information.

```
[DotDevice getExportFileInfo];
[DotDevice setExportFileInfoDone:^(BOOL success) { }];
```

4.13.3 Set export file list

All the available recording files will be saved in *recording.files* array. Export file list is a *DotDevice.recording.files* index array. You must set export file list via *recording.exportFileList* before start export file data, otherwise no files will be exported. The max index cannot exceed *DotDevice.recording.files.count*.

```
NSArray *array = [[NSArray alloc] initWithObjects:@0, @1, @2, nil];
DotDevice.recording.exportFileList = array;
or
NSArray *array = [[NSArray alloc] initWithObjects:@2, nil];
DotDevice.recording.exportFileList = array;
```

4.13.4 Start export

Before starting to export the data file, make sure you have set the export data format and get the export file information.

```
[DotDevice startExportFileData];
```

Call *ExportFileDone* block after the data export is finished:

```
[DotDevice.recording setExportFileDone:^(NSUInteger index, BOOL result) { }];
```

If you want to use recording export file data, call parse file data block:

```
[DotDevice setDidParseExportFileDataBlock:^(DotPlotData * _Nonnull plotData) { }];
```

4.13.5 Stop export

Stop export file data.

```
[DotDevice stopExportFileData];
```

4.13.6 Update export status

UpdateExportingStatus block will be updated after calling *startExportFileData* and *stopExportFileData*.

```
[DotDevice.recording setUpdateExportingStatus:^(XSEExportStatus status) { }];
```

Table 19: Export status

Export status	Description
XSEExportIsExportingData	The flash is exporting recording data
XSEExportIsStopExportingData	Data exporting is stopped

4.14 mFirmware update

Continuous firmware releases from Movella are scheduled for new features, improvements, and bug fixes. With Over-the-Air (OTA) firmware update function in the Movella DOT, you can easily update the sensors to latest firmware version.

With the OTA functions in the SDK, you can do the firmware update in your own application from the Movella DOT update server via OTA.

NOTE:

- Sensors can only upgrade or downgrade when **in charging status**.
- Network connection is required for OTA. Check the network connection before checking for firmware update.

All the firmware update related methods are in the *DotOtaManager.h* header file. And the parameter is *DotDevice* object. Make sure the device is initialized before calling the related methods. All the callback methods are in the *DotOtaManagerDelegate* class.

4.14.1 Set the delegate

Set the delegate in your ViewController class:

```
- (void) viewWillAppear:(BOOL) animated
{
    [super viewWillAppear:animated];
    [DotReconnectManager setEnable:YES];
    ...
}
```

4.14.2 Check firmware update

Based on the current firmware version and release type, you can check if there is new firmware version available with *checkOtaUpdates*. This function is usually used when you just want to check if there is new firmware available.

```
[[DotOtaManager defaultManager] checkOtaUpdates:device];
```

After calling *checkOtaUpdates*, *onOtaUpdates* method will be triggered. If the result = YES and version is not an empty string, it means there is a firmware that can be updated. The result would be "No" if there is no new firmware available.

```
(void) onOtaUpdates:(NSString *)address result:(BOOL)result
version:(NSString *)version releaseNotes:(NSString *)releaseNotes;
```

Use *checkOtaUpdatesAndDownload* method if you want to download the firmware file (.mfw) after checking and start the OTA process.

After calling *checkOtaUpdatesAndDownload* method, there will be two callbacks. One is the *onOtaUpdates*, which is the same as calling *checkOtaUpdates*. The other is *onOtaDownload*. If the available firmware has been downloaded, this method will be triggered:

```
(void) onOtaDownload:(NSString *)address version:(NSString *)version;
```

4.14.3 Check firmware downgrade

Firmware downgrade function is provided to downgrade the beta firmware versions to the last stable version. Stable firmware versions cannot downgrade to any previous versions.

Moreover, if a new stable version is available, beta versions cannot rollback to previous stable versions. You can only update the beta versions to the new stable version under this circumstance.

Similar to checking update, you can use *checkOtaRollback* method to check if the sensor can rollback.

```
[[DotOtaManager defaultManager] checkOtaRollback:device];
```

After calling *checkOtaRollback*, *onOtaRollback* method will be triggered. If the result = YES and version is not an empty string, it means that there is a firmware that can be rolled back. The result would be "No" if there is no firmware available.

```
(void)onOtaRollback:(NSString *)address result:(BOOL)result  
version:(NSString *)version releaseNotes:(NSString *)releaseNotes;
```

Use *checkOtaRollbackAndDownload* method if you want to download the firmware file (.mfw) after checking and start the OTA process.

```
[[DotOtaManager defaultManager]checkOtaRollbackAndDownload:device];
```

After calling *checkOtaRollbackAndDownload* method, there will be two callbacks. One is the *onOtaRollback*, which is the same as calling *checkOtaRollback*. The other is *onOtaDownload*. If the available firmware has been downloaded, this method will be triggered:

```
(void)onOtaDownload:(NSString *)address version:(NSString *)version
```

4.14.4 Start OTA

You can start the OTA process once the target firmware file has been downloaded. Start the OTA by calling *startOta* method:

```
[[DotOtaManager defaultManager] startOta:device];
```

During the OTA process, the firmware file will be transmitted to the sensor and updated. You can get the OTA status from these callback methods:

1. *onOtaStart* – The OTA has started successfully.
2. *onOtaProgress* – The OTA is still in progress.
3. *onOtaEnd* – The OTA has ended successfully and the update or downgrade is done.

```
(void)onOtaStart:(NSString *)address result:(BOOL)result  
errorCode:(int)errorCode;
```

```
(void)onOtaProgress:(NSString *)address progress:(float)progress  
errorCode:(int)errorCode;
```

```
(void)onOtaEnd:(NSString *)address result:(BOOL)result  
errorCode:(int)errorCode;
```

The OTA will fail if any of the above stages fails. There are some common reasons for OTA failure:

1. Failed to send 'start OTA' and 'stop OTA' commands.
2. OTA file is not sent completely and is always retransmitting. This is usually due to the insufficient Bluetooth performance of the mobile device.
3. Sensor is out of charging status during OTA.
4. Sensor disconnects during OTA.

The *onOtaFileMismatch* callback will be called if the new firmware file does not match the current sensor. The OTA process will end.

```
(void)onOtaFileMismatch:(NSString *)address;
```

The *onOtaUncharged* callback will be called if the sensor is not in charging and the OTA process will end.

```
(void)onOtaUncharged:(NSString *)address;
```

4.14.5 Stop OTA

You can stop the OTA when it is still in progress:

```
[[DotOtaManager defaultManager] stopOta:device];
```

After stopOta method, this callback will be triggered:

```
(void)onOtaEnd:(NSString *)address result:(BOOL)result  
errorCode:(int)errorCode;
```

4.14.6 Clear the cache file

The downloaded firmware files will be saved in Library/Caches/\${BundleId}/ota folder. You can delete them by using *clearCache* method.

```
[[DotOtaManager defaultManager] clearCache]
```

4.15 Mag field mapper

When Movella DOT sensor is mounted to an object that contains ferromagnetic materials, the measured magnetic field can become distorted, causing errors in measured orientation. To correct for known magnetic disturbances, Magnetic Field Mapper function has been developed to allow users to remap the magnetic field of the sensor.

The MFM can be executed in a few minutes and yields a new set of calibration values that can be written to the Movella DOT's non-volatile memory, which means it will not be erased by powering off or firmware updates.

With the SDK, you can start/stop MFM, start data processing, get mtb output data and write it to sensor.

Figure 8: MFM Workflow shows the recommended workflow to start and stop MFM with Android SDK.

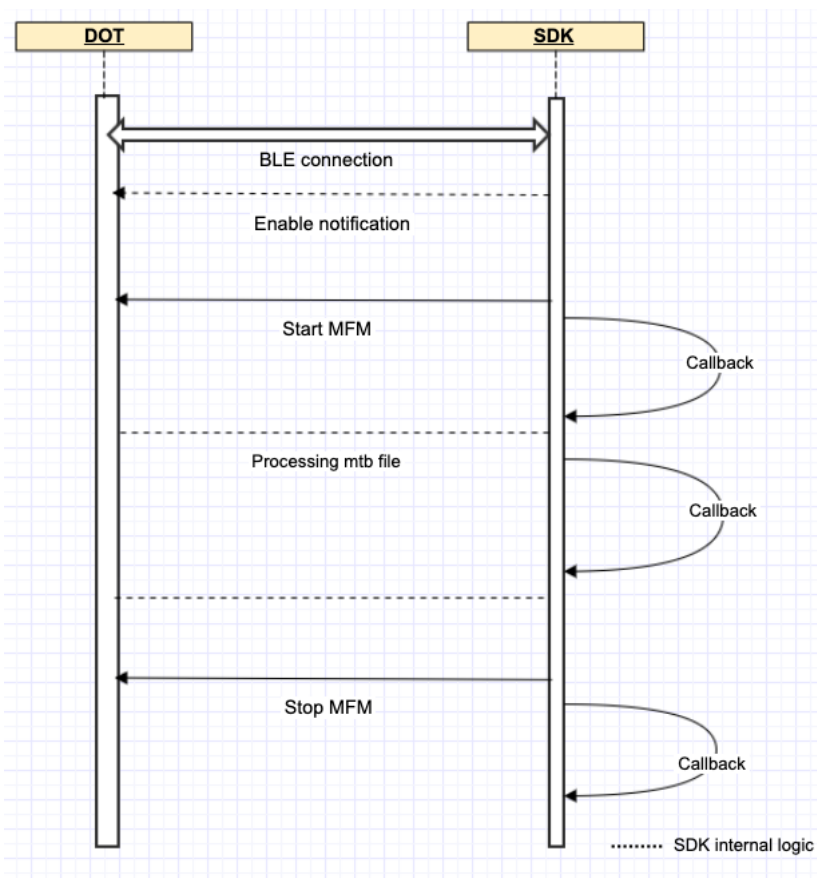

Figure 8: MFM Workflow

4.15.1 Integrate MFM SDK framework

- Import the whole `MovellaDotSdkMfm.framework` package into the target project.

- Make sure `MovellaDotSdkMfm.framework` is included in **Target** → **General** → **Framework, Libraries, and Embedded Content**, and the **Embed** property is **'Embed & Sign'**

4.15.2 Implementation MFM

1. Set MFM delegate in viewController

```
[[DotMFManager defaultManager] setMfmDelegate:self];
```

2. Implement the DotMFDelegate interfaces

```
- (void)onMFProgress:(int)progress address:(NSString *)address
{
    ...
}

- (void)onMFCompleted:(XSDotMFResultType)type address:(NSString *)address
{
    ...
}
```

3. Start MFM

When calling `startMFM()` method, the MFM process will be started, then the `onMFProgress()` method will be triggered. Developer can listen the progress of MFM through this. When the progress reaches to 100, the MFM will be on processing state. After MFM process finished, the `onMFCompleted()` will be triggered, developer can know the MFM state by the parameter type.

```
[[DotMFManager defaultManager] startMFM:self.mfmDevices];
```

4. Stop MFM

If you want to stop current MFM process, you can call this `stopMFM()`. After call this method, the MFM process will be stopped and `onMFCompleted()` will be triggered.

```
[[DotMFManager defaultManager] stopMFM:self.mfmDevices];
```

4.16 Other functions

4.16.1 Read RSSI

While scanning sensors, you can use the property `RSSI` to get the RSSI:

```
DotDevice.RSSI
```

You can also read RSSI when sensor is connected by `readRSSI` method.

```
[DotDevice readRSSI:^(NSNumber * _Nonnull signal) {
    }];
```

4.16.2 Identify

To identify or find your device, you can call the following function. The device will fast blink 8 times and then a short pause when you call this function.

```
[DotDevice startIdentifying];
```

4.16.3 Power saving

In power-saving mode, sensors will turn off the signal pipeline and BLE connection and put the MCU in a sleep state to ensure minimum power consumption. The default time threshold to enter power saving mode is set to 10 min in advertisement mode and 30 min in connection mode. These values are saved in the non-volatile memory and can be adjusted in Movella DOT app or SDK.

There is an example to set power saving time in advertisement and connection mode both to 30 minutes.

```
[DotDevice setPowerSavingTimeout:30 xSecond:0 yMinutes:30 ySeconds:0];
```

4.16.4 Button callback

If there is a single click on the power button during connection, a notification will be sent with a timestamp when this single click is released. This function is called as "Button callback".

When the pressing time is 10~800ms, it is judged as a valid single click. The timestamp is from sensor's local clock and independent of synchronization.

```
[DotDevice setDidButtonCallbackBlock:^(int timestamp) {  
    }];
```

4.16.5 Power on options

This feature is to allow user to configure the Movella DOT v2 sensor to be powered on by USB plugin or not. This setting is only available in v2 sensor.

By default, power on by USB is disabled. So, the sensor will be in charging status if connected with USB cable. You can call *enableUsbPowerOn()* to set enable this feature.

```
[DotDevice enableUsbPowerOn:YES];
```

By enabling USB power on, the sensor will power on immediately after the USB plugin. With this feature, you can power on multiple sensors with the USB plugin at once.

5 Appendix

5.1 Real-time streaming modes

NOTE:

You can get other data quantities from the available data in each measurement mode. Refer to section 4.10.6 for the conversions that can be used.

5.1.1 Extended (Quaternion)

Table 20: Extended (Quaternion)

Mode name	Payload	Available data
XSBleDevicePayloadExtendedQuaternion	36 bytes	<ul style="list-style-type: none">• SampleTimeFine• Orientation (Quaternions)• Free acceleration• Status

5.1.2 Complete (Quaternion)

Table 21: Complete (Quaternion)

Mode name	Payload	Available data
XSBleDevicePayloadCompleteQuaternion	32 bytes	<ul style="list-style-type: none">• SampleTimeFine• Orientation (Quaternions)• Free acceleration

5.1.3 Orientation (Quaternion)

Table 22: Orientation (Quaternion)

Mode name	Payload	Available data
XSBleDevicePayloadOrientationQuaternion	20 bytes	<ul style="list-style-type: none">• SampleTimeFine• Orientation (Quaternions)

5.1.4 Extended (Euler)

Table 23: Extended (Euler)

Mode name	Payload	Available data
XSBleDevicePayloadExtendedEuler	32 bytes	<ul style="list-style-type: none">• SampleTimeFine• Orientation (Euler angles)• Free acceleration• Status

5.1.5 Complete (Euler)

Table 24: Complete (Euler)

Mode name	Payload	Available data
XSBleDevicePayloadCompleteEuler	28 bytes	<ul style="list-style-type: none">• SampleTimeFine• Orientation (Euler angles)• Free acceleration

5.1.6 Orientation (Euler)

Table 25: Orientation (Euler)

Mode name	Payload	Available data
XSBleDevicePayloadOrientationEuler	16 bytes	<ul style="list-style-type: none">• SampleTimeFine• Orientation (Euler angles)

5.1.7 Free acceleration

Table 26: Free acceleration

Mode name	Payload	Available data
XSBleDevicePayloadFreeAcceleration	16 bytes	<ul style="list-style-type: none">• SampleTimeFine• Free acceleration

5.1.8 High fidelity (with mag)

Table 27: High fidelity (with mag)

Mode name	Payload	Available data
XSBleDevicePayloadInertialHighFidelityWithMag	35 bytes	<ul style="list-style-type: none">• SampleTimeFine• dq• dv• Angular velocity• Acceleration• Magnetic field• Status

5.1.9 High fidelity

Table 28: High fidelity

Mode name	Payload	Available data
XSBleDevicePayloadHighFidelityNoMag	29 bytes	<ul style="list-style-type: none">• SampleTimeFine• dq• dv• Angular velocity• Acceleration• Status

5.1.10 Delta quantities (with mag)

Table 29: Delta quantities (with mag)

Mode name	Payload	Available data
XSBleDevicePayloadDeltaQuantitiesWithMag	38 bytes	<ul style="list-style-type: none">• SampleTimeFine• dq• dv• Magnetic field

5.1.11 Delta quantities

Table 30: Delta quantities

Mode name	Payload	Available data
XSBleDevicePayloadDeltaQuantitiesNoMag	32 bytes	<ul style="list-style-type: none">• SampleTimeFine• dq• dv

5.1.12 Rate quantities (with mag)

Table 31: Rate quantities (with mag)

Mode name	Payload	Available data
XSBleDevicePayloadRateQuantitiesWithMag	34 bytes	<ul style="list-style-type: none">• SampleTimeFine• Angular velocity• Acceleration• Magnetic Field

5.1.13 Rate quantities

Table 32: Rate quantities

Mode name	Payload	Available data
XSBleDevicePayloadRateQuantitiesNoMag	28 bytes	<ul style="list-style-type: none">• SampleTimeFine• Angular velocity• Acceleration

5.1.14 Custom mode 1

Table 33: Custom mode 1

Mode name	Payload	Available data
XSBleDevicePayloadCustomMode1	40 bytes	<ul style="list-style-type: none">• SampleTimeFine• Orientation (Euler angles)• Free acceleration• Angular velocity

5.1.15 Custom mode 2

Table 34: Custom mode 2

Mode name	Payload	Available data
XSBleDevicePayloadCustomMode2	34 bytes	<ul style="list-style-type: none">• SampleTimeFine• Orientation (Euler angles)• Free acceleration• Magnetic field

5.1.16 Custom mode 3

Table 35: Custom mode 3

Mode name	Payload	Available data
XSBleDevicePayloadCustomMode3	32 bytes	<ul style="list-style-type: none">• SampleTimeFine• Orientation (Quaternions)• Angular velocity

5.1.17 Custom mode 4

Table 36: Custom mode 4

Mode name	Payload	Available data
XSBleDevicePayloadCustomMode4	51 bytes	<ul style="list-style-type: none">• SampleTimeFine• Orientation (Quaternions)• dq• dv• Angular velocity• Acceleration• Magnetic field• Status

5.1.18 Custom mode 5

Table 37: Custom mode 5

Mode name	Payload	Available data
XSBleDevicePayloadCustomMode5	44 bytes	<ul style="list-style-type: none">• SampleTimeFine• Orientation (Quaternions)• Acceleration• Angular velocity